

***ENS26 Automatic Isolation Unit
Operating Manual***

Issue 09/2005

UfE Umweltfreundliche Energieanlagen GmbH
Joachim-Jungius-Straße 9
D-18059 Rostock

Tel.: +49 3 81 / 405 97 05
Fax: +49 3 81 / 405 97 03
E-mail: post@ufegmbh.de
web: www.ufegmbh.de



Note

If you have any queries and need to contact UfE GmbH, always have the serial number close to hand in order to make reference to it. We do not claim the documentation is free of errors and mistakes. Please inform UfE GmbH of any errors found in the documentation.

© Copyright

This operating manual is the copyright of UfE GmbH.
This manual is intended for the operator and electrician. It contains instructions and information which must not be copied, distributed or transferred by technical data methods nor used for the purpose of competition, either as an entirety or as extracts, without the necessary authorisation. Contravention could lead to prosecution and obligation to pay damages.
All rights reserved, particularly in the case of patent application or other registrations.
We reserve the right to make technical modifications without notice.



Note

The ENS26 isolation unit and the measuring method are protected by patent.



We

Ufe Umweltfreundliche Energieanlagen GmbH
Joachim-Jungius-Straße 9
18059 Rostock

declare in sole responsibility that the product

Type: **ENS26 Automatic Isolation Unit**

Serial number: _____

fulfils the applicable health and safety requirements in the EU Directives 89/336/EEC (Electromagnetic Compatibility EMC) and 73/23/EEC (low voltage guidelines) and the law reorganising the safety of technical apparatus and consumer products (law on equipment and product safety), as well as the requirements stipulated in other applicable, harmonised European Norms

In addition, the following directive is also fulfilled:
89/391/EEC (employee safety and health protection)

Rostock, _____

K.-W. Köln
Manager

1	Safety	5
1.1	General information	5
1.2	Safety symbols used in this operating manual.....	5
1.3	Obligations.....	6
1.3.1	Obligations of the proprietor.....	6
1.3.2	Obligation of personnel.....	6
1.4	Guarantee and liability.....	7
1.5	Accident prevention regulations.....	8
1.6	Intended use.....	9
1.6.1	Exclusive purpose.....	9
1.6.2	Observe information and regulations	9
1.7	Installation and connection	10
1.8	Operation.....	10
1.9	Rating plate and CE symbol	11
2	System Description	12
2.1	Principles of functioning.....	12
2.2	LCD display and LEDs	13
2.3	Connections.....	14
3	Operation	15
3.1	Switching the system on.....	15
3.1.1	Optional LCD displays during the power-on routine.....	15
3.1.2	LED indicators during the power-on routine.....	16
3.2	LCD displays during operation (optional).....	16
3.3	Switching the system off.....	18
4	Troubleshooting	19
4.1	General information	19
4.2	Error indications in the optional LCD	19
4.2.1	Error status for voltage.....	19
4.2.2	Error status for frequency	19
4.2.3	Error status for impedance.....	20
4.2.4	Faults in the ENS 26 isolation unit	20
4.2.5	Error texts for mains power fluctuations.....	21
4.3	Error indication through LEDs.....	22
5	Technical Data	23

1 Safety

1.1 General information

This chapter contains information on safety and rules of conduct. It is essential to observe the information and rules so that any residual risks represented by the product do not lead to a fault or an accident.

The device must be connected to the local power supply. Therefore, all the normal risks involved in the use of electrical power are present here, too.

1.2 Safety symbols used in this operating manual

The following symbols are used at the relevant points throughout this manual. Pay strict attention to the information provided in these sections and proceed with the utmost care.

Meaning of the safety symbols:

**Danger**

This symbol indicates the risk of fatal or personal injury if certain rules of conduct are disregarded. When this symbol appears in the operating manual, take all the necessary safety precautions.

**Attention**

This symbol indicates the risk of property damage as well as financial and legal disadvantages (e.g. loss of rights to claims under the terms of guarantee, liability, etc.).

**Note**

This symbol indicates important information on working efficiently, economically and ecologically.

1.3 Obligations

1.3.1 Obligations of the proprietor

The proprietor is obliged only to allow suitably trained personnel to work with the ENS26 isolation unit who

- are familiar with the basic regulations on safety and accident prevention,
- have read the operating manual, the chapter on safety and the safety symbols, have understood them and confirmed this with their signature.

The proprietor must always ensure the entire product documentation is at the disposal of operating personnel.

**Danger**

The proprietor bears the responsibility for safety. This responsibility cannot be delegated.

1.3.2 Obligation of personnel

Personnel must:

- be in possession of a license to connect electronic equipment to the public electricity supply,
- always ensure for themselves that third-parties and the equipment are safe,
- maintain the safety and connection regulations of the power supply provider,
- have read and understood the operating instructions, the chapter on safety and warning labels,
- observe the applicable regulations concerning industrial safety and accident prevention.

**Danger**

This concerns the safety of yourself and other persons in the vicinity of the ENS26 as well as safety when working with the mains electricity supply.

1.4 Guarantee and liability

Our "General Terms of Sale and Delivery" apply. The proprietor has claim to these on conclusion of the contract at the latest. Rights to claims under the terms of guarantee and liability in respect of persons and property are considered void when they are the result of one or more of the following causes:

- Unintended use of the ENS26,
- Improper start up, operation and service of the ENS26,
- Failure to observe information in the overall documentation in respect of
 - installation, connection
 - starting up
 - operation
 - cleaning/servicing
- Unauthorised constructional modifications to the ENS26,
- Damage through overvoltage, overload, short circuit, mechanical interference, moisture,
- Case of catastrophe caused by foreign body or Act of God.

**Attention**

No modification may be carried out on the ENS26 without the approval of the manufacturer.

**Attention**

Never attempt to repair the device yourself. All rights to claims under the terms of guarantee are annulled in the case of tampering.

1.5 Accident prevention regulations

Any faults which occur that affect safety must be eliminated immediately. The ENS26 may not be operated until the fault has been cleared.

**Danger**

Solar modules conduct electricity as soon as they are exposed to daylight. Observe this when laying and connecting the cables and take the necessary precautions.

**Danger**

It is forbidden to open the unit. The box can continue to conduct dangerous residual voltage some minutes after being switched off.

1.6 Intended use

The ENS26 has been built according to state-of-the-art technology and accepted safety regulations.

However, when the unit is used, there remains a risk of fatal and personal injury to the user and third-parties as well as impairment of the unit and other property damage.

1.6.1 Exclusive purpose

The ENS26 is exclusively intended for monitoring voltage, frequency and impedance of one phase of the electricity network at the feeding point of a power generating system. On detecting over- and undervoltages, frequency deviation or impedance jumps, the ENS26 disconnects all poles of the feeding point from the public electricity supply.

Any other use is considered unintended use. The manufacturer is not liable for any consequential damage in such cases.

1.6.2 Observe information and regulations

Intended use also includes

- observing all information provided in this operating manual and
- maintaining the connection and installation conditions prescribed by the manufacturer.

1.7 Installation and connection

Observe the separate Installation Manual with regard to installing and connecting the ENS26.



Danger

It is forbidden to open the unit. The unit can continue to conduct dangerous residual voltage some minutes after being switched off.

1.8 Operation

Operation of the ENS26 is impermissible:

- for monitoring tasks for which the unit is not designed,
- when using accessories which have not been approved by the manufacturer,
- when the proprietor has made constructional modifications.

Functional faults must be analysed immediately. If necessary, the proprietor must request specialist assistance. The equipment may only be put into operation again when there is no doubt about its safety.

The ENS26 is intended for operation at room temperatures between - 20 °C and + 40 °C (also refer to Chapter 5, Technical Data).

Contact a suitably trained electrician or the manufacturer in the following cases:

- connection cable is damaged,
- liquids or foreign bodies have got inside the unit,
- the unit has been exposed to water or rain,
- the unit has fallen down or is mechanically damaged,
- the unit behaves in a way indicating a fault (e.g. indication or message on the optional LCD, constant switching).

1.9 Rating plate and CE symbol

The manufacturer has provided the following information on the ENS26 at the positions indicated:

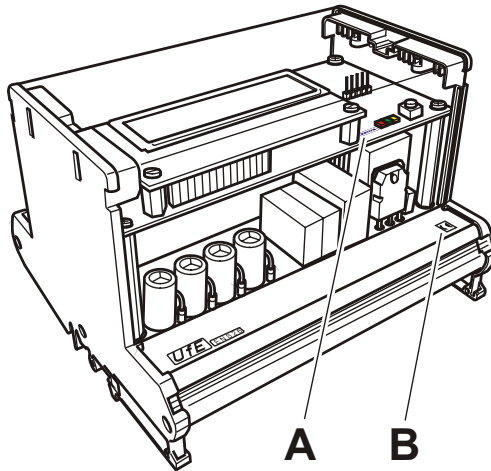

A) Serial number

The manufacturer's serial number for the ENS26 is provided at this point.

B) CE symbol

The CE symbol is located at the bottom right corner of the front side:



Note

Always make reference to the ENS26 serial number in the case of inquiries, orders and contracts. This simplifies communication with the manufacturer and prevents errors when processing requests.

2 System Description

2.1 Principles of functioning

The automatic, one-phase ENS26 isolation unit is an automatic switch which is used to connect decentralised electricity generators to the public electricity supply.

In the event of faults in the mains supply, the ENS26 interrupts the feeding of electricity of the monitored phase into the mains to prevent an island effect.

The following deviations are monitored:

- overvoltage and undervoltage
- frequency deviation
- impedance jumps

The isolation unit replaces an otherwise prescribed manual isolation unit to which the power supply authorities must have permanent access.

**Note**

Further information on the principles of functioning is available on our Internet site at www.ufegmbh.de.

2.2 LCD display and LEDs

The following indicators are provided on the front side of the ENS26:

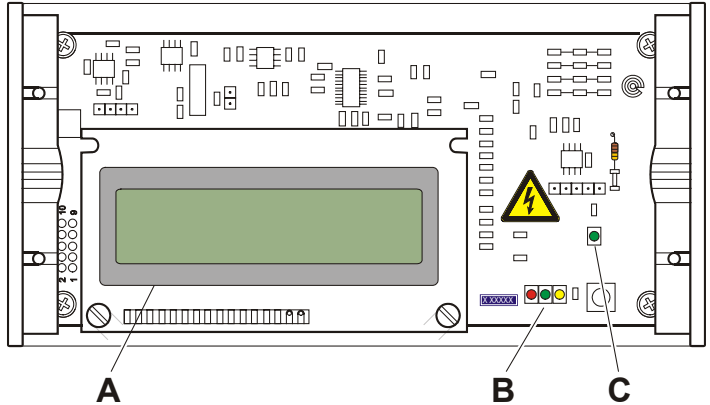

A) LCD display (optional)

The equipment status as well as the status of the monitored phase are provided in a 2-line LC display. Each line can contain 16 characters.

B) LEDs of the phase monitoring

In addition to the optional LCD display, the unit status and status of the monitored phase are also indicated by the three LEDs (red, green, yellow):

C) LED of the self-monitoring (green)

This LED flashes during normal operation and indicates that the self-monitoring feature is active.



Note

The meaning of the LCD display and LED indicators is described in Chapter 3 Operation and Chapter 4 Troubleshooting.

2.3 Connections

The following connections are provided at the top edge of the ENS26:

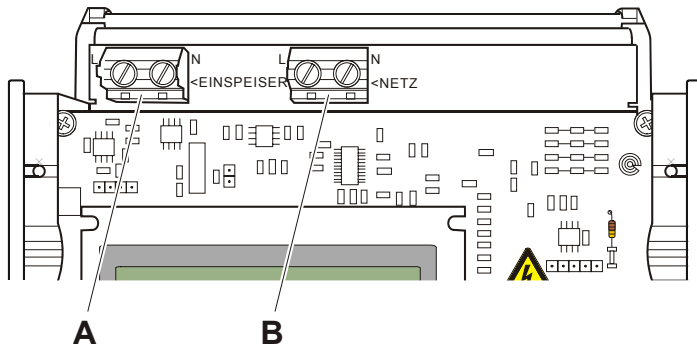

- A** 2 connection terminals to connect one phase and the neutral conductor (feeding unit)
- B** 2 connection terminals to connect one phase and the neutral conductor (mains)



Note

The connection of the unit is described in the Installation Manual.

3 Operation

3.1 Switching the system on

The ENS26 starts up automatically after switching on the mains power supply.

3.1.1 Optional LCD displays during the power-on routine

The optional LCD indicates the status of the power-on routine:

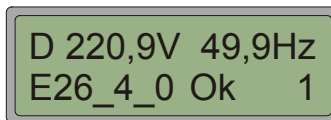



The first character indicates the status of the ENS. The following states can occur during the power-on routine:

Indicator	Meaning
i	Following a reset, the ENS26 is in its initialised state.
w	After initialisation, all the error bits are deleted and the system waits a fixed time.
r	The ENS26 is waiting for a return signal.
^	The ENS26 switches on after the waiting period.
D F I	The ENS26 is switched on, the mains power is within a permissible range and power is fed. The mains power is monitored constantly. The letters indicate: D = Setting for Germany, Austria and Switzerland, F = Setting for France, I = Setting for Italy.
X	The ENS26 has interrupted power feed.

3.1.2 LED indicators during the power-on routine

The three indicator LEDs for unit and phase status light up as follows during the power-on routine:

Indicator	Meaning
	All LEDs light up to begin with.
	After approx. 1 sec., a running light is activated.
	The mains power is in order and the ENS26 switches it on. During operation, the yellow LED can flash or light up continually.

3.2 LCD displays during operation (optional)

The LCD runs through the following display modes cyclically:

First display

Country identification, mains voltage, mains frequency, power-on routines since last rest, mains condition and software version or error messages.

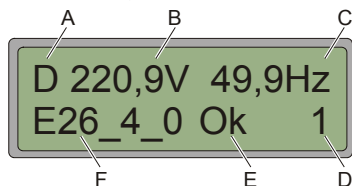

Indicator	Meaning
A	Country identification plus error status. Country identification letters signify the following: D = Setting for Germany, Austria and Switzerland, F = Setting for France, I = Setting for Italy.
B	Mains voltage of the monitored phase.
C	Mains frequency.
D	Number of power-ons since the last reset.
E	Mains power status ok.
F	Software version or error messages (if applicable).

Second display

Data from the 10-minute average values.

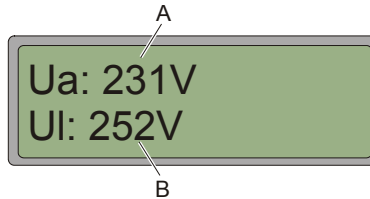

Indicator	Meaning
A	10-minute average value of voltages plus error status of the mains supply.
B	Upper shutdown threshold for the 10-minute average value.

Third display

Impedances of the monitored phase and shutdown thresholds.

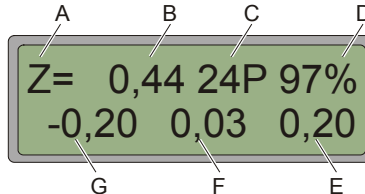

Indicator	Meaning
A	Phase status.
B	Estimated value for absolute impedance of this phase.
C	Number of measuring pulses per second.
D	Own share of the ENS26 in the total measuring signal.
E	Dynamic upper shutdown threshold for the impedance jump.
F	Last established impedance jump.
G	Dynamic lower shutdown threshold for the impedance jump.

Fourth display

Last error which occurred, information is lost following ENS reset.

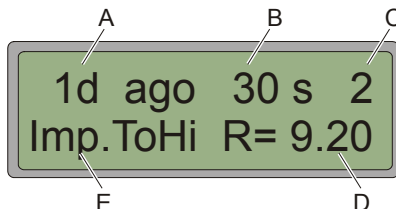

Indicator	Meaning
A	Time since last error (s = seconds, m = minutes, h = hours, d = days, w = weeks, a = years)
B	Duration of last error (s = seconds, m = minutes, h = hours, d = days, w = weeks, a = years)
C	Power-on routines since last reset.
D	Error text (also refer to Chapter 4)
E	Error value (in the example: the impedance of the phase was too high = 9.2 ohm)

If hardware or mains errors occur, the bottom line of the first display contains an error text.



Note

The meaning of the error texts and error status displays are described in Chapter 4 “Troubleshooting”.



Attention

Check the functionality of the ENS26 regularly. If, for example, a red LED lights up constantly, the ENS26 may be defective and no power is fed in (also refer to Chapter 4 “Troubleshooting”).

3.3 Switching the system off

The ENS26 cannot be switched off. The unit switches to an idling state if no voltage is supplied. It resumes its tasks as soon as sufficient power is available.

4 Troubleshooting

4.1 General information

In the case of repeated problems with the mains supply (e.g. frequent deactivation due to mains overvoltage or undervoltage), contact the public electricity supply authority and have the mains power quality checked at the feeding point.

A frequent disconnection from the mains power supply can be observed particularly in rural areas and areas with strong power fluctuations due to the proximity of industrial plants.

4.2 Error indications in the optional LCD

4.2.1 Error status for voltage

LCD indication	Cause	Recommended action
^250	Overvoltage	If the mains power fluctuations occur frequently, contact your public electricity supply authority.
v150	Undervoltage	
/280	Undervoltage in the case of fast shutdown	
_130	Undervoltage in the case of fast shutdown	
M250	Overvoltage in 10-minute average value	

4.2.2 Error status for frequency

LCD indication	Cause	Recommended action
^50.90	Frequency is too high	If the mains power fluctuations occur frequently, contact your public electricity supply authority.
v48.00	Frequency is too low	
j48.00	Frequency jump was detected (RoCoF)	

4.2.3 Error status for impedance

LCD indication	Cause	Recommended action
^ 9,25	Impedance is implausibly too high.	If the mains power fluctuations occur frequently, contact your public electricity supply authority.
v -0,99	Impedance is implausibly too low (negative).	
n 0,33 p 0,44	Impedance jumps have been detected.	

4.2.4 Faults in the ENS 26 isolation unit

In the event of errors, the following text appears in the bottom line of the first display:

LCD indication	Meaning
Hardware1Err###	A measuring error or hardware error has caused in the ENS26 has caused a shutdown. The following digits (###) are error codes for reference by the manufacture. If the error occurs only briefly, it is probably due to a measuring error. If the ENS26 does not switch on at all, it must be replaced.
Hardware2Err###	
Hardware3Err###	
TimeErr###	



Note





The ENS26 cannot be repaired on site. Please inform the specialist workshop that a replacement is required.

4.2.5 Error texts for mains power fluctuations

In the event of a power fluctuation, one of the following texts appears in the bottom line of the first display:

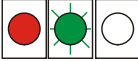
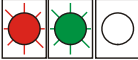
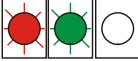
LCD indication	Meaning
Imp.PJp dR= 1.20 Imp.NJp dR=-1.20	An impedance jump has been detected
Imp.ToHi R= 9.20 Imp.ToLo R=-0,99	The impedance is too high or too low.
Freq.ToHi F=50.83 Freq.ToLo F=46.83	The frequency is too high or too low.
Frq.Jmp dF=-600	Shutdown following RoCoF, value in mHz/s
Spa.Thi Ua=260.0	The mains voltage is too high, response time 10 minutes.
Spa.ToHi U=265.3 Spa.ToLo U=130.4	The mains voltage is too high or too low, response time 200 ms.
Spa.Thi Uf=310.0 Spa.TLo Uf=120.3	The mains voltage is too high or too low, response time 20 ms, fast shutdown to protect unit

4.3 Error indication through LEDs

LCD indication	Cause	Recommended action
 Red lights up, green flashes	Frequency error	Wait until the mains is switched on again. Contact the public electricity authority in the case of longer power failures.
 Red and green flash simultaneously	Voltage error	
 Red and green flash alternately	Impedance error	
 or 	Display of impedance jump threshold value: lights up briefly = 0.1 ohm lights up longer = 0.5 ohm. short, short, long = $0.1 + 0.1 + 0.5 = 0.7 \text{ Ohm}$ LED continually on: threshold is set to 1 ohm or more.	
 Red lights up	Measuring error or ENS26 has failed	If the LED lights up longer than 1 minute with mains available, the ENS26 is defective. Have the ENS26 replaced by a specialist workshop.



Note

The ENS26 cannot be repaired on site. Please inform the specialist workshop that a replacement is required.

5 Technical Data

Switched power	max. 5750 W
Own consumption	1.5 W
Housing	Plastic, suitable for assembly on the top hat rail
Overall dimensions (W x H x D)	146 mm x 111 mm x 80 mm
Cut-out dimensions (W x H)	146 mm x 73 mm
Ambient conditions	- 20 °C to + 40 °C, 10 to 90 % relative humidity, non-condensating
Nominal current of power feeder	max. 25 A
The unit disconnects the mains under the following defined conditions (complying with standard DIN VDE 0126):	
Overvoltage (fast shutdown)	> 300 V (response time 0.02 s)
Overvoltage	> 264 V (response time 0.2 s)
Overvoltage (average)	230 V + 10% over 10 minutes
Undervoltage (fast shutdown)	< 130 V (response time 0.02 s)
Undervoltage	< 185 V (response time 0.2 s)
Frequency deviation	+ 0.2 Hz / -2,5 Hz (response time 0.2 s)
RoCoF = Rate of Change of Frequency	> 1 Hz/s
Impedance jump detection	> 0.5 Ohm (response time 0.5 s)



For your notes