

***ENS31 Automatic Isolation Unit
Installation and Operating Manual***

UfE Umweltfreundliche Energieanlagen GmbH
Joachim-Jungius-Straße 9
D - 18059 Rostock

Tel.: +49 3 81 / 405 97 05
Fax: +49 3 81 / 405 97 03
E-mail: vertrieb@ufegmbh.de
web: www.ufegmbh.de



Note

If you have any queries and need to contact UfE GmbH, always have the serial number close to hand in order to make reference to it. We do not claim the documentation is free of errors and mistakes. Please inform UfE GmbH of any errors found in the documentation.

© Copyright

This operating manual is the copyright of UfE GmbH.

This manual is intended for the operator and electrician. It contains instructions and information which must not be copied, distributed or transferred by technical data methods nor used for the purpose of competition, either as an entirety or as extracts, without the necessary authorisation.

Contravention could lead to prosecution and obligation to pay damages.

All rights reserved, particularly in the case of patent application or other registrations.

We reserve the right to make technical modifications without notice.



Note

The ENS31 isolation unit and the measuring method are protected by patent.

We

**UfE Umweltfreundliche Energieanlagen GmbH
Joachim-Jungius-Straße 9
D - 18059 Rostock**

declare in sole responsibility that the product

Type: ENS31 Automatic Isolation Unit

fulfils the applicable health and safety requirements in the EU Directives

89/336/EEC (Electromagnetic Compatibility EMC) and
73/23/EEC (low voltage guidelines)

and the law reorganising the safety of technical apparatus and consumer products (law on equipment and product safety), as well as the requirements stipulated in other applicable, harmonised European Norms.

In addition, the following directive is also fulfilled:

89/391/EEC (employee safety and health protection)

Klaus-Wilhelm Köln
Manager

Table of Contents

| | | |
|----------|--|-----------|
| 1 | Safety..... | 6 |
| | 1.1 General information | 6 |
| | 1.2 Safety symbols used in this operating manual | 6 |
| | 1.3 Obligations..... | 7 |
| | 1.3.1. Obligations of the proprietor | 7 |
| | 1.3.2. Obligation of personnel | 7 |
| | 1.4 Guarantee and liability..... | 8 |
| | 1.5 Accident prevention regulations | 9 |
| | 1.6 Intended use..... | 9 |
| | 1.6.1 Exclusive purpose | 9 |
| | 1.6.2 Observe information and regulations | 9 |
| | 1.7 Installation and connection | 10 |
| | 1.8 Operation..... | 10 |
| | 1.9 Rating plate and CE symbol | 11 |
| 2 | Connections and Indicators | 12 |
| | 2.1 Connections..... | 12 |
| | 2.2 LCD display and LEDs | 13 |
| 3 | Mechanical Installation | 14 |
| | 3.1 Transport and unpacking..... | 14 |
| | 3.2 Conditions for installation | 14 |
| | 3.3 Preparing the electrical/meter cabinet..... | 15 |
| | 3.4 Mounting on the top hat rail..... | 15 |
| | 3.5 Removing from the top hat rail | 16 |
| 4 | Electrical Connections..... | 17 |
| | 4.1 Basic configuration | 17 |
| | 4.2 Demands of the switching elements..... | 17 |
| | 4.3 Circuitry | 18 |
| | 4.4 Disconnection | 19 |
| 5 | System Description | 20 |
| | 5.1 Principles of functioning..... | 20 |
| 6 | Function Test..... | 21 |
| | 6.1 Switching the system on..... | 21 |
| | 6.2 Indicators during operation | 21 |
| 7 | Operation | 22 |
| | 7.1 Switching the system on..... | 22 |



| | | |
|-----------|--|-----------|
| 7.2 | LED indicators during the power-on routine | 23 |
| 7.3 | LCD displays during operation..... | 23 |
| 7.4 | Switching the system off | 25 |
| 8 | Troubleshooting | 26 |
| 8.1 | General information | 26 |
| 8.2 | Error indications in the LCD..... | 26 |
| 8.2.1 | Error status for voltage | 26 |
| 8.2.2 | Error status for frequency | 26 |
| 8.2.3 | Error status for phase angle | 27 |
| 8.2.4 | Error status for impedance | 27 |
| 8.2.5 | Faults in the ENS 31 isolation unit..... | 27 |
| 8.2.6 | Error texts for mains power fluctuations | 28 |
| 8.2.7 | Hardware Errors ENS31 | 29 |
| 8.2.8 | Error indication through LEDs | 30 |
| 9 | Technical Data | 31 |
| 10 | Certificate of Non-Objection..... | 32 |

1 Safety

1.1 General information

This chapter contains information on safety and rules of conduct. It is essential to observe the information and rules so that any residual risks represented by the product do not lead to a fault or an accident.

The device must be connected to the local power supply. Therefore, all the normal risks involved in the use of electrical power are present here, too.

1.2 Safety symbols used in this operating manual

The following symbols are used at the relevant points throughout this manual. Pay strict attention to the information provided in these sections and proceed with the utmost care.

Meaning of the safety symbols:



Danger

This symbol indicates the risk of fatal or personal injury if certain rules of conduct are disregarded. When this symbol appears in the operating manual, take all the necessary safety precautions.



Attention

This symbol indicates the risk of property damage as well as financial and legal disadvantages (e.g. loss of rights to claims under the terms of guarantee, liability, etc.).



Note

This symbol indicates important information on working efficiently, economically and ecologically.

1.3 Obligations

1.3.1. Obligations of the proprietor

The proprietor is obliged only to allow suitably trained personnel to work with the ENS31 isolation unit who

- are familiar with the basic regulations on safety and accident prevention
- have read the operating manual, the chapter on safety and the safety symbols, have understood them and confirmed this with their signature.

The proprietor must always ensure the entire product documentation is at the disposal of operating personnel.

**Danger**

The proprietor bears the responsibility for safety. This responsibility cannot be delegated.

1.3.2. Obligation of personnel

Personnel must:

- be in possession of a license to connect electronic equipment to the public electricity supply,
- always ensure for themselves that third-parties and the equipment are safe,
- maintain the safety and connection regulations of the power supply provider,
- have read and understood the operating instructions, the chapter on safety and warning labels,
- observe the applicable regulations concerning industrial safety and accident prevention.

**Danger**

This concerns the safety of yourself and other persons in the vicinity of the ENS31 as well as safety when working with the mains electricity supply.

1.4 Guarantee and liability

Our "General Terms of Sale and Delivery" apply. The proprietor has claim to these on conclusion of the contract at the latest. Rights to claims under the terms of guarantee and liability in respect of persons and property are considered void when they are the result of one or more of the following causes:

- Unintended use of the ENS31,
- Improper start up, operation and service of the ENS31,
- Failure to observe information in the overall documentation in respect of
 - installation, connection
 - starting up
 - operation
 - cleaning/servicing
- Unauthorised constructional modifications to the ENS31,
- Damage through overvoltage, overload, short circuit, mechanical interference, moisture,
- Case of catastrophe caused by foreign body or Act of God.

**Attention**

No modification may be carried out on the ENS31 without the approval of the manufacturer.

**Attention**

Never attempt to repair the device yourself. All rights to claims under the terms of guarantee are annulled in the case of tampering.

1.5 Accident prevention regulations

Any faults which occur that affect safety must be eliminated immediately. The ENS31 may not be operated until the fault has been cleared.



Danger

Solar modules conduct electricity as soon as they are exposed to daylight. Observe this when laying and connecting the cables and take the necessary precautions.



Danger

It is forbidden to open the unit. The box can continue to conduct dangerous residual voltage some minutes after being switched off.

1.6 Intended use

The ENS31 has been built according to state-of-the-art technology and accepted safety regulations.

However, when the unit is used, there remains a risk of fatal and personal injury to the user and third-parties as well as impairment of the unit and other property damage.

1.6.1 Exclusive purpose

The ENS31 is exclusively intended for monitoring voltage, frequency and impedance of the electricity network at the feeding point of a power generating system. On detecting over- and undervoltages, frequency deviation or impedance jumps, the ENS31 disconnects the feeding point from the public electricity supply by means of contactors.

Any other use is considered unintended use. The manufacturer is not liable for any consequential damage in such cases.

1.6.2 Observe information and regulations

Intended use also includes

- observing all information provided in this operating manual and
- maintaining the connection and installation conditions prescribed by the manufacturer.

1.7 Installation and connection

For installation and connection of the ENS31 please observe chapters 2 to 5.



Danger

It is forbidden to open the unit. The unit can continue to conduct dangerous residual voltage some minutes after being switched off.

1.8 Operation

Operation of the ENS31 is impermissible:

- for monitoring tasks for which the unit is not designed,
- when using accessories which have not been approved by the manufacturer,
- when the proprietor has made constructional modifications.

Functional faults must be analysed immediately. If necessary, the proprietor must request specialist assistance. The equipment may only be put into operation again when there is no doubt about its safety.

The ENS31 is intended for operation at room temperatures between - 20 °C and + 40 °C (also refer to Chapter 9).

Contact a suitably trained electrician or the manufacturer in the following cases:

- connection cable is damaged,
- liquids or foreign bodies have got inside the unit,
- the unit has been exposed to water or rain,
- the unit has fallen down or is mechanically damaged,
- the unit behaves in a way indicating a fault (e.g. indicator on the LCD, constant switching).

1.9 Rating plate and CE symbol

The manufacturer has provided the following information on the ENS31 at the positions indicated:

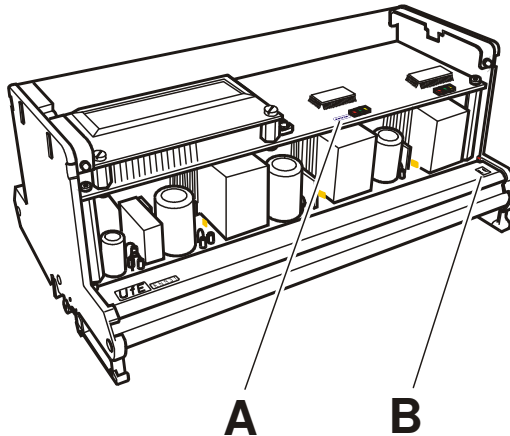

A Serial number

The manufacturer's serial number for the ENS31 is provided at this point.

B CE-symbol

The CE symbol is located at the bottom right corner of the front side.



Note

Always make reference to the ENS31 serial number in the case of inquiries, orders and contracts. This simplifies communication with the manufacturer and prevents errors when processing requests.

2 Connections and Indicators

2.1 Connections

The following connections are provided at the top edge of the ENS31:

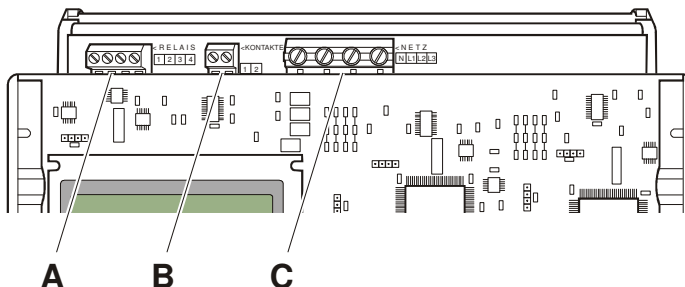

- A** 4 connection terminals for contactor control, potential-free; designation from left to right: R1, R2, R3 and R4
- B** 2 connection terminals to connect positively driven auxiliary contacts; designation from left to right: K1 and K2
- C** 4 connection terminals to connect three phases and the neutral conductor; designation from left to right: N, L1, L2 and L3

2.2 LCD display and LEDs

The following indicators are mounted on the front side of the ENS31:

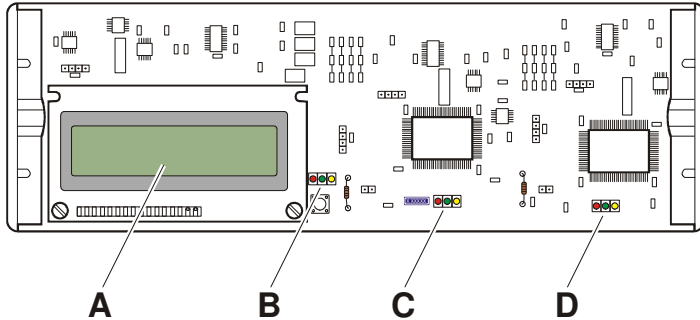

A LCD display

The unit and mains power status are shown on a 2-line LC display. Each line can display 16 characters.

B to D LEDs

In addition to the LCD, the unit and mains power status are also indicated by three LEDs (red, green, yellow):

B = LED display for phase 1 (L1)

C = LED display for phase 2 (L2)

D = LED display for phase 2 (L3).



Note

The meaning of the indicators is described in chapter 7 and chapter 8.

3 Mechanical Installation

3.1 Transport and unpacking

When transporting the ENS31 isolation unit, pay attention that it is always protected against contact with dirt and damage through impacts and setting down too hard.

Remove the ENS31 from the transport packaging and pull off the protective foil, if necessary.

After transport and before installation, check that the ENS31 isolation unit is in a perfect condition.

3.2 Conditions for installation

The ENS31 is intended for installation on a top hat rail in an electrical cabinet or in a meter cabinet. It cannot be installed anywhere.

The cabinet must be sufficiently large to house the ENS31, providing the necessary contactors and protect the unit from moisture, dust, dirt and heat.

If there is not enough space in the cabinets available, a separate electrical cabinet must be mounted to accommodate the ENS31 and contactors.



Attention

Never position the electrical cabinet containing the ENS31 above or in the vicinity of a heater. Ensure sufficient ventilation.

The ENS31 should be mounted as near as possible to the mains power outlet and as far as possible from the electricity feeding source.



Note

These measures reduce the effect of voltage increase by the current source.

3.3 Preparing the electrical/meter cabinet

Determine the installation position of the ENS31 on the top hat rail.

Saw a cut-out in the cabinet cover at the installation position of the ENS31 so that you can see the ENS31 and its indicators (LCD and LEDs) without opening the cabinet.

The cut-out must have the following dimensions:

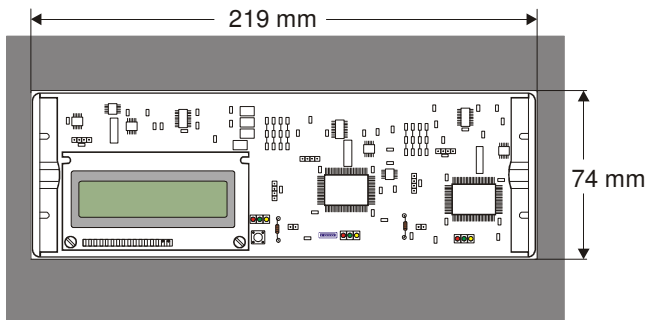

3.4 Mounting on the top hat rail

Set the isolation unit with its top housing holder (A) on the top hat rail and turn it downwards against the top hat rail (B). Use a little force to press on the bottom housing section until the housing holder engages in the top hat rail.

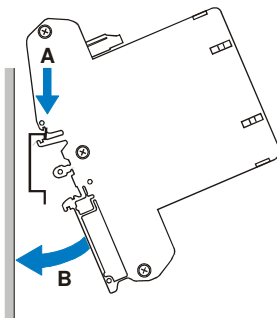

3.5 Removing from the top hat rail

The ENS31 can be removed from the top hat rail.

Insert the tip of a screwdriver in the grooves (A) in the clamps at the ends of the housing. Pull the clamps downwards (B). The ENS31 is released. Remove the ENS31 by turning it a little (C) away from the top hat rail.

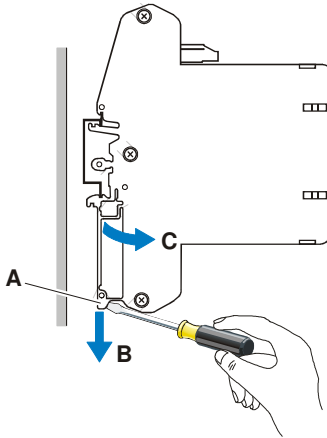

Attention

Never remove the ENS31 from the top hat rail using brute force. This could damage the housing holders.

4 Electrical Connections

4.1 Basic configuration

The switching elements of the automatic isolating device (e.g. contactors) are not enclosed with the unit and must be brought by the installation technician. The technician decides on the switching elements most suitable.

**Danger**

The installation technician must ensure that the power generator is only connected to the mains via the two switching elements assigned to the ENS. Risk of accident!

The ENS31 must be protected by pre-fuses in the mains feed circuit (min. 6 A, max. 25 A). Observe the circuit diagram.

4.2 Demands of the switching elements

Two contactors with positively driven auxiliary contacts are required for mains disconnection. The feedback contacts must be connected in the correct sequence (refer to circuit diagram).

The contactors must be designed for the nominal output of the current inverter or the system at AC3. The decisive factor for dimensioning is the phase with the highest load.

4.3 Circuitry

Check that the mains power lines and power feed lines are not conducting electricity.

Switch the power generator (feeder), ENS31 and contactors as follows (**note the turning direction**):

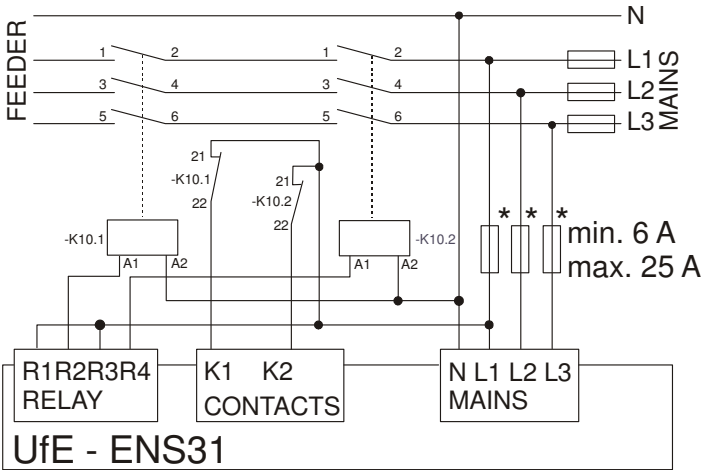

Note

The additional pre-fuse () is only necessary if the direct mains power fuse protection exceeds 25 A.*

The terminals on the ENS31 are arranged as follows:

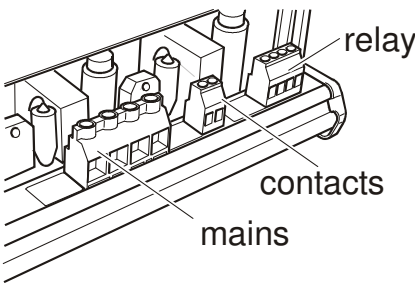

**Attention**

*The ground conductor should always bypass the unit. **The neutral conductor MUST be connected to the ENS31** otherwise the unit may be damaged.*

If the ENS31 is switched on and off by means of a system control unit, the L1 connection of the ENS31 can be switched by means of a relay.

**Note**

When switching on via L1, the delay until the contactors are activated can be up to 30 seconds because the ENS31 must test the power feed conditions again.

4.4 Disconnection

Switch off the power supply to the mains power lines and lines from the power generator (feeder).

Wait until the isolation unit has removed all the residual voltages.

**Danger**

The isolation unit can still conduct dangerously high residual voltage some minutes after being switched off. Risk of accident!

Disconnect the mains power lines, contactor lines and relay lines.

Insulate bare contacts from mains power lines, contactor lines and relays (e.g. using insulation tape).

The ENS31 can then be removed from the top hat rail (also refer to Chapter 3.5).

5 System Description

5.1 Principles of functioning

The automatic, three-phase ENS31 isolation unit is an automatic switch which is used to connect decentralised electricity generators to the public electricity supply.

In the event of faults in the mains supply, the ENS31 interrupts the feeding of electricity into the mains to prevent an island effect.

The following deviations are monitored:

- overvoltage and undervoltage
- frequency deviation
- impedance jumps

The isolation unit replaces an otherwise prescribed manual isolation unit to which the power supply authorities must have permanent access.



Note

Further information on the principles of functioning is available on our Internet site at www.ufegmbh.de.

6 Function Test

6.1 Switching the system on

Switch the isolation unit on first and then the power generator (feeder).

The ENS starts up automatically after switching on the mains supply.

The following appears on the LCD display after a successful self-test and mains test:

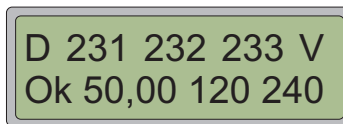

When the voltage, frequency and mains impedance are in the permissible range for 20 seconds, the contactors are triggered and power feed in the public electricity supply begins. The mains power is then monitored.

6.2 Indicators during operation

After switching on, the values for voltage, impedance and frequency are displayed alternately (refer to chapter 7).

7 Operation

7.1 Switching the system on

The LCD indicates the status of the power-on routine:

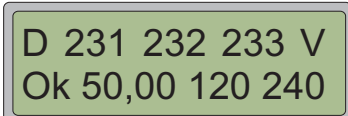



D 231 232 233 V
Ok 50,00 120 240

The first character indicates the status of the ENS. The following states can occur during the power-on routine:

| Indicator | Meaning |
|-------------|---|
| i | Following a reset, the ENS31 is in its initialised state. |
| w | After initialisation, all the error bits are deleted and the system waits a fixed time. |
| r | The ENS31 is waiting for a return signal. |
| ^ | The ENS31 switches on after the waiting period. |
| D F I | The ENS31 is switched on, the mains power is within a permissible range and power is fed. The mains power is monitored constantly. The letters indicate: D = Setting for Germany, Austria and Switzerland, F = Setting for France, I = Setting for Italy. |
| X | The ENS31 has interrupted power feed. |

7.2 LED indicators during the power-on routine

LEDs are provided for each individual phase and light up as follows during the power-on routine:

| Indicator | Meaning |
|---|---|
|  | All LEDs light up to begin with. |
|  | After approx. 1 sec., a running light is activated. |
|  | The mains power is in order and the ENS31 switches it on. During operation, the yellow LED can flash or light up continually. |

7.3 LCD displays during operation

The LCD runs through the following display modes cyclically:

First display

Error status, mains voltages, power-on routines since last rest, mains frequency, phase angle and error messages.

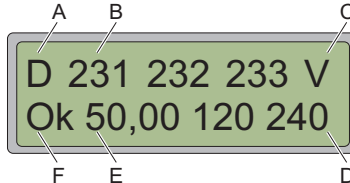

| Indicator | Meaning |
|-----------|---|
| A | Country identification plus error status. Country identification letters signify the following: D = Setting for Germany, Austria and Switzerland, F = Setting for France, I = Setting for Italy. |
| B | Mains voltage of the individual phases plus error status. L1 = left, L2 = middle, L3 = right. |
| C | Number of power-ons since the last reset. |
| D | Phase angle plus error status. The phase angle L1-L3 is to the right, phase angle L1-L2 is to the left. |
| E | Mains frequency and error status. |
| F | Mains power status ok. |

Second display

Data from the 10-minute average values.

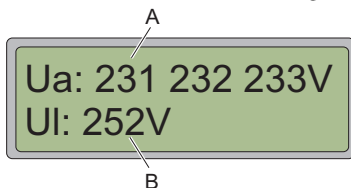

| Indicator | Meaning |
|-----------|---|
| A | 10-minute average value of voltages plus error status. L1 = left, L2 = middle, L3 = right. |
| B | Upper shutdown threshold for the 10-minute average value. |

Third to fifth display

Impedances of the three phases and shutdown thresholds.

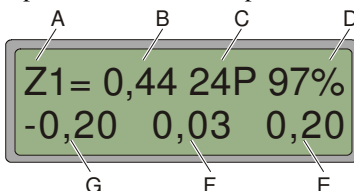

| Indicator | Meaning |
|-----------|--|
| A | Phase identification (L1, L2 or L3) and error status. |
| B | Estimated value for absolute impedance of this phase. |
| C | Number of measuring pulses per second. |
| D | Own share of the ENS31 in the total measuring signal. |
| E | Dynamic upper shutdown threshold for the impedance jump. |
| F | Last established impedance jump. |
| G | Dynamic lower shutdown threshold for the impedance jump. |

Sixth display

Last error which occurred, information is lost following ENS reset.

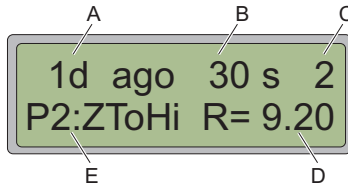

| Indicator | Meaning |
|-----------|--|
| A | Time since last error (s = seconds, m = minutes, h = hours, d = days, w = weeks, a = years) |
| B | Duration of last error (s = seconds, m = minutes, h = hours, d = days, w = weeks, a = years) |
| C | Power-on routines since last reset. |
| D | Error text (also refer to Chapter 8) |
| E | Error value (in the example: the impedance of 9.2 ohm was too high on phase 2) |

If hardware or impedance errors occur, the bottom line of the first display contains an error text.



Note

The meaning of the error texts and error status displays are described in Chapter 8.



Attention

Check the functionality of the ENS31 regularly. If, for example, a red LED lights up constantly, the ENS31 may be defective and no power is fed in (also refer to Chapter 8).

7.4 Switching the system off

The ENS31 cannot be switched off. The unit switches to an idling state if no voltage is supplied. It resumes its tasks as soon as sufficient power is available.

8 Troubleshooting

8.1 General information

In the case of repeated problems with the mains supply (e.g. frequent deactivation due to mains overvoltage or undervoltage), contact the public electricity supply authority and have the mains power quality checked at the feeding point.

A frequent disconnection from the mains power supply can be observed particularly in rural areas and areas with strong power fluctuations due to the proximity of industrial plants.

8.2 Error indications in the LCD

8.2.1 Error status for voltage

| LCD indication | Cause | Recommended action |
|----------------|---|---|
| ^250 | Overvoltage | If the mains power fluctuations occur frequently, contact your public electricity supply authority. |
| v150 | Undervoltage | |
| /280 | Undervoltage in the case of fast shutdown | |
| _130 | Undervoltage in the case of fast shutdown | |
| M250 | Overvoltage in 10-minute average value | |

8.2.2 Error status for frequency

| LCD indication | Cause | Recommended action |
|----------------|-------------------------------------|---|
| ^50,90 | Frequency is too high | If the mains power fluctuations occur frequently, contact your public electricity supply authority. |
| v48,00 | Frequency is too low | |
| j48,00 | Frequency jump was detected (RoCoF) | |

8.2.3 Error status for phase angle

| LCD indication | Cause | Recommended action |
|----------------|---|---|
| !170 | Phase angle deviates too far from setpoint. | If the mains power fluctuations occur frequently, contact your public electricity supply authority. |
| !240!120 | Wrong direction of rotation of mains. | Swap phases L1 and L2 at the connection terminals. |

8.2.4 Error status for impedance

| LCD indication | Cause | Recommended action |
|------------------|--|---|
| ^ 9,25 | Impedance is implausibly too high. | If the mains power fluctuations occur frequently, contact your public electricity supply authority. |
| v -0,99 | Impedance is implausibly too low (negative). | |
| n 0,33 p 0,44 | Impedance jumps have been detected. | |

8.2.5 Faults in the ENS 31 isolation unit

In the event of errors, the following text appears in the bottom line of the first or sixth display:

| LCD indication | Cause |
|----------------|---|
| HRD1Err### | A measuring error or hardware error has caused in the ENS31 has caused a shutdown. The 3 digits (###) are error codes for reference by the manufacture. If the error occurs only briefly, it is probably due to a measuring error. If the ENS31 does not switch on at all, it must be replaced. |
| HRD2Err### | |
| HRD3Err### | |
| TMRErr### | |



Note

The ENS31 cannot be repaired on site. Please inform the specialist workshop that a replacement is required.

8.2.6 Error texts for mains power fluctuations

In the event of a power fluctuation, one of the following texts appears in the bottom line of the first or sixth display:

| LCD indication | Meaning |
|--|--|
| P* : ZPjP dR= 1.20 P* : ZNJp dR=-1.20 | An impedance jump has been detected. |
| P* : ZToHi R= 9.20 P* : ZToLo R=-0,99 | The impedance is too high or too low. |
| P* : FToHi F=50.83 P* : FToLo F=46.83 | The impedance is too high or too low. |
| P* : FrqJp dF=-600 | Shutdown following RoCoF, value in mHz/s |
| P* : F Pha2 W=180° P* : F Pha2 W=200° P* : F Pha2 W=664° | Shutdown due to too great a phase angle deviation Phase L2/L3 interchanged |
| P* : UTHi Ua=260.0 | The mains voltage is too high, response time 10 minutes. |
| P* : UToHi U=265.3 P* : UToLo U=130.4 | The mains voltage is too high or too low, response time 200 ms. |
| P* : UTHi Uf=310.0 P* : UTL0 Uf=120.3 | The mains voltage is too high or too low, response time 20 ms, fast shutdown to protect unit |

- stands for 1, 2 or 3 and indicates the phase affected L1, L2 or L3

8.2.7 Hardware Errors ENS31

Wiring faults / Contactors





HRD1

| LCD indication | Meaning | Cause |
|----------------|--|---|
| HRD1 01 00 00 | NC contact of contactor 1 is open bevor contactor 1 is activated. | NC contact not connected according to item 4.3. |
| HRD1 02 00 00 | NC contact of contactor 2 is open bevor contactor 2 is activated. | NC contact not connected according to item 4.3. |
| HRD1 04 00 00 | Contactor 1 activates even with missing enabling signal | Enabling defective / contactor incorrectly wired |
| HRD1 08 00 00 | NC contact of contactor 1 does not open even if contactor 1 is activated | Contactor 1 does not operate / contactor incorrectly wired, NC contact not correctly connected, NC contact interchanged |
| HRD1 40 00 00 | Contactor 2 activates even with missing enabling signal | Enabling defective / contactor incorrectly wired |
| HRD1 80 00 00 | NC contact of contactor 2 does not open even if contactor 2 is activated | Contactor 2 does not operate / contactor incorrectly wired, NC contact not correctly connected, NC contact interchanged |

HRD2

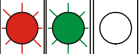
| LCD indication | Meaning | Cause |
|----------------|---|---|
| HRD2 01 00 00 | Contactor 1 deactivates with valid input signal | Contactor 1 faulty |
| HRD2 02 00 00 | Contactor 2 deactivates with valid input signal, NC contact 2 opens with contactor 1 activated. | Contactor 2 faulty, NC contact interchanged, one contactor controls both signal inputs. |

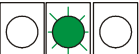
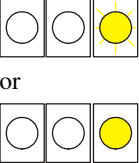
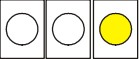
8.2.8 Error indication through LEDs

| LED indication | Cause | Recommended action |
|---|--|---|
|  Red lights up, green flashes | Frequency error | Wait until the mains is switched on again. Contact the public electricity authority in the case of longer power failures. |
|  Red and green flash simultaneously | Voltage error | |
|  Red and green flash alternately | Impedance error | |
|  Green lights up with short interruptions | Measured value(s) outside the factory tolerance | Mains power is ok. |
|  Green flashes rapidly | ENS31 waiting for acknowledgement from inverse rectifier | Mains power is ok. |
|  or  | Display of impedance jump threshold value: lights up briefly = 0.1 ohm lights up longer = 0.5 ohm. short, short, long = $0.1 + 0.1 + 0.5 = 0.7 \text{ Ohm}$ LED continually on: threshold is set to 1 ohm or more. | |
|  Red lights up | Measuring error or ENS31 has failed | If the LED lights up longer than 1 minute with mains available, the ENS31 is defective. Have the ENS31 replaced by a specialist workshop. |

9 Technical Data

| | |
|--|---|
| Switched power (max.) | Dependent on the contactors assigned |
| Own consumption | 3.5 W |
| Housing | Plastic, suitable for assembly on the top hat rail |
| Overall dimensions (W x H x D) | 220 mm x 111 mm x 80 mm |
| Cut-out dimensions (W x H) | 220 mm x 73 mm |
| Ambient conditions | - 20 °C to + 40 °C, 10 to 90 % relative humidity, non-condensating |
| Nominal current of power feeder | According to max. switching power of the contactors |
| The unit disconnects the mains under the following defined conditions (complying with standard DIN VDE 0126): | |
| Overvoltage (fast shutdown) | > 300 V (response time 0.02 s) |
| Overvoltage | > 264 V (response time 0.2 s) |
| Overvoltage (average) | 230 V + 10% over 10 minutes |
| Undervoltage (fast shutdown) | < 130 V (response time 0.02 s) |
| Undervoltage | < 185 V (response time 0.2 s) |
| Frequency deviation | + 0,2 Hz / -2,5 Hz (response time 0.2 s) |
| Impedance jump detection | > 0.5 Ohm (response time 0.5 s) |

